

Welcome Aboard
Wilkommen
Benvenuti
Olla

ᄀ ᄁ ᄂ ᄃ

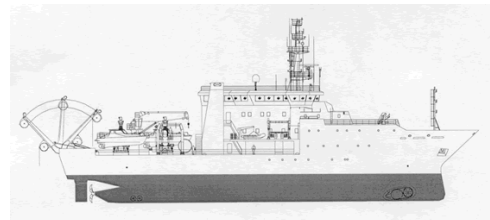
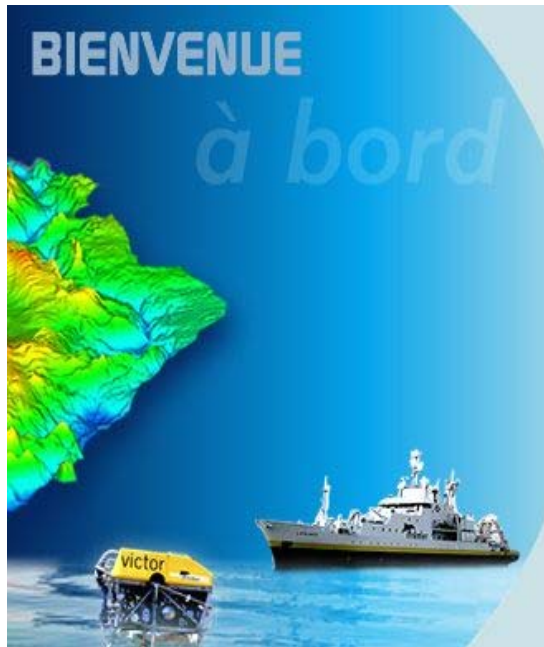

ifremer

<http://www.ifremer.fr/flotte/index.html>

Vincent.rigaud@ifremer.fr

(Ifremer) Existing operational Underwater Systems and field of work

From survey

to

Intervention

Autonomous



ASTERX 3000m
, 100km, 24h

Cabled systems and ROV



>100km
Sev Days

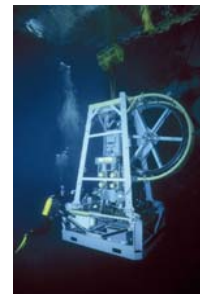

local, sev h



sev km, 72h

HOV: Nautilie

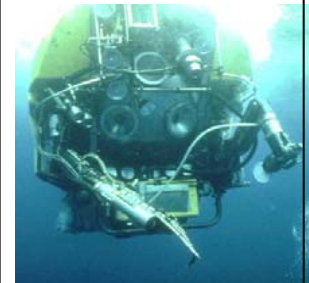

sev km, sev h

RandD New AUV
concept
heterogeneous fleet



space

fremer

time

Discovery
Survey
Monitoring
Sampling



Other scientific underwater
Structured fields : Observatory

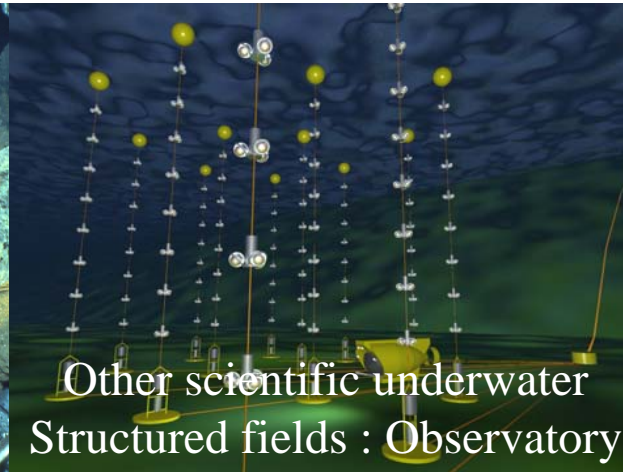

Offshore Technological

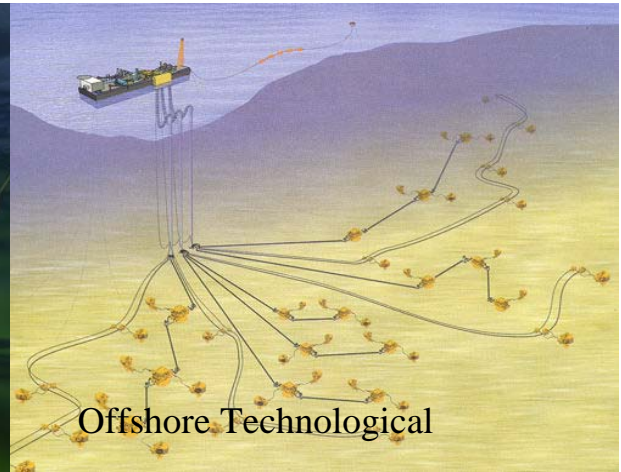

Underwater Intervention @ Ifremer

Systems, system of systems and methods

- **Engineering for the Ifremer national mean agency**
 - ➔ Tow systems : 25 000 km profiles
 - ➔ HOV : more than 3 000 plongées in 30 Years
 - ➔ VICTOR 6000 : more than 4200 hours in 10 Years
 - ➔ IDEF^x, ASTER^x : Survey AUV on an operational learning curve, 3500km in 30months
 - ➔ Observatories engineering, design, installation and maintenance
- **Contributive, funded, RandD under contracts**
 - ➔ Underwater systems, robotics, navigation, positioning, acoustic, optic
 - ➔ Pioneer for hybrid and intervention AUVs
- ➔ **40 Engineers and technicians working with 40 operational Technicians and crews within Génavir for operational deployment and first level maintenance**
 - ➔ New systems design , design authority functions
 - ➔ Existing systems evolutions, large overhauls, cycle of life management
 - ➔ RandD on systems and subsystems
 - ➔ Procedures

Engineering and research department For Underwater systems

Département Systèmes sous-Marins

DOP/DCM/SM

30781

Directeur : V. Rigaud

Secrétaire : A. Laurantin

Projet Ingénierie Opérationnelle : JF. Drogou
Projet AUV : J. Opderbecke
Projet Module Mesures en Route
et ingénieur responsable *Victor 6000* : P. Siméoni
Ingénieur en charge du *Nautil* : JP. Lévêque **
Responsable Qualité : L. Brisset
Assistant projet & communication : M. Bonnefoy
Correspondante Administrative : V. Asseline •

*Service Positionnement,
Robotique, Acoustique,
Optique – PRAO*

M. Perrier

30783

Secrétariat : V. Lemaire

AG. Allais
P. Arzellès
A. Bonnassié*
M.E. Bouhier
V. Brandou*
B. Duchêne
P. Duformentelle
M. Drogou
T. Edmond
C. Gibaudan

*Service Systèmes
Electroniques, Electriques
Embarqués – S3E*

P. Léon

30784

Secrétariat : A. Merien

D. Chenot
S. Dentrecolas
B. Galizi
Y. Hillion ***
C. Marfia
H. Martinossi
F. Roland
X. Saint-Laurent
C. Pernot **

*Service Ingénierie
d'Intervention et
Développements
Mécaniques – 2IDM*

M. Luccioni

30782

Secrétariat : M. Sciarrone
E. Boy (rempl.) ***

L. Artzner
V. Ciausu ***
JP. Gilliotte
C. Lévêque
C. Martin
A. Massol
B. Puigserver
P. Valdy
JM. Viaène
D. Santarelli **
G. Trento **

**+ 40 Technicians within Genavir for the Operations
And first level maintenance**



**European Center of Underwater Technologies
La Seyne sur Mer-Toulon on the Med sea!**

Ifremer

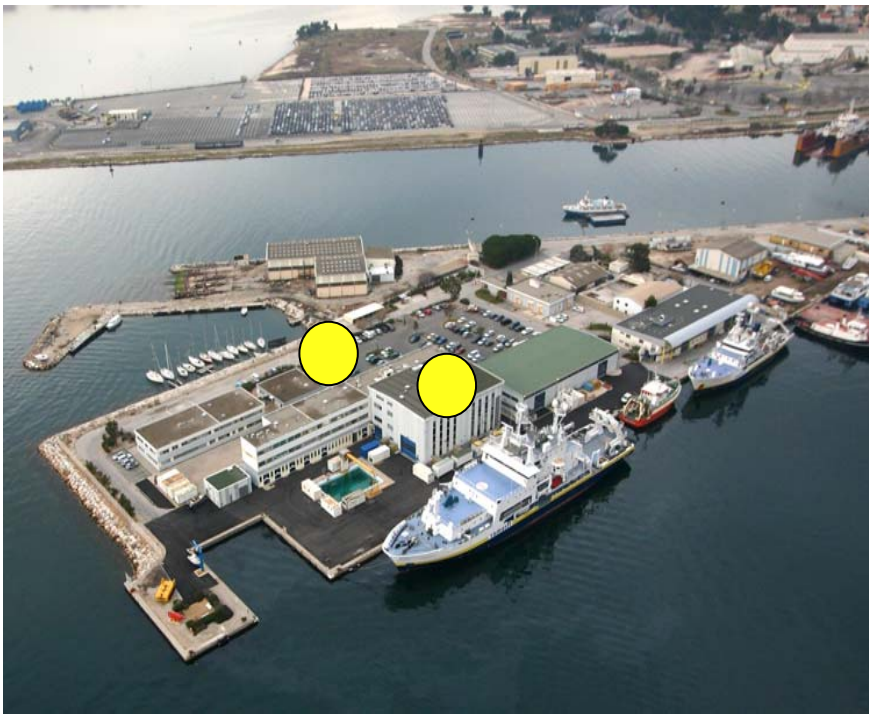

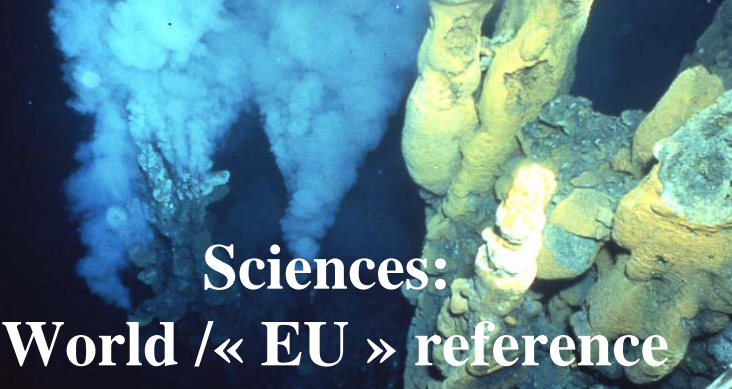

Sciences:
World /« EU » reference



System of systems
Maturity and competencies



Nautille HOV

1500 dives in 20 years



Operational system

Victor 6000 scientific ROV

- 320 dives in 8 years,
- 4200h – 3400h on the bottom
«performances!»
- 2 toolsets
- Patents and licences on sub systems (manipulators, USBL...)
- Operated from several EU ships (Sarmiento, Polarstern...)
- First Large overhaul 2008-2009



Cooperations

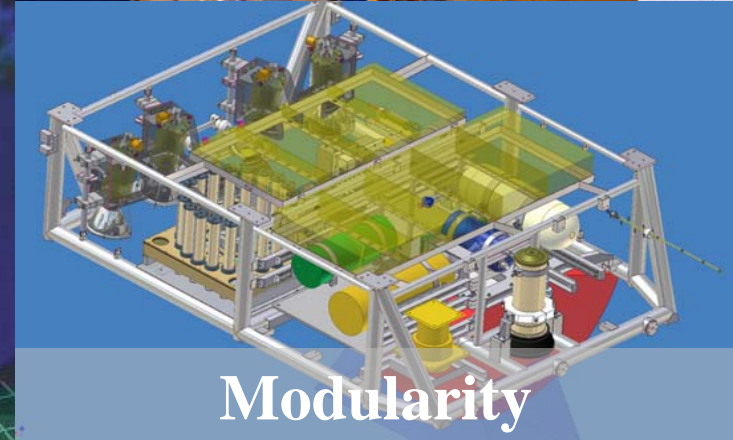

Modularity



Interoperability

New “en route” Module: HR multimodal mapping with Multibeam and optic with AWI

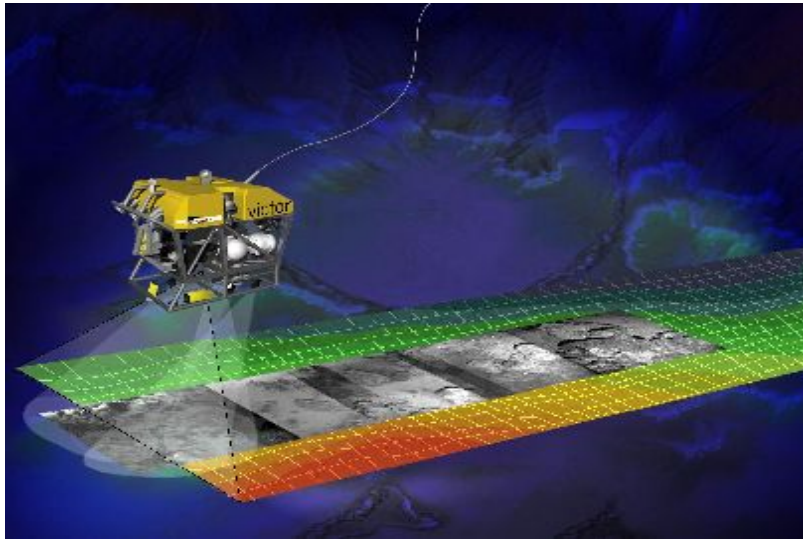

+ ground truth
of surface surveys,
With instrumentations
and
teleoperation

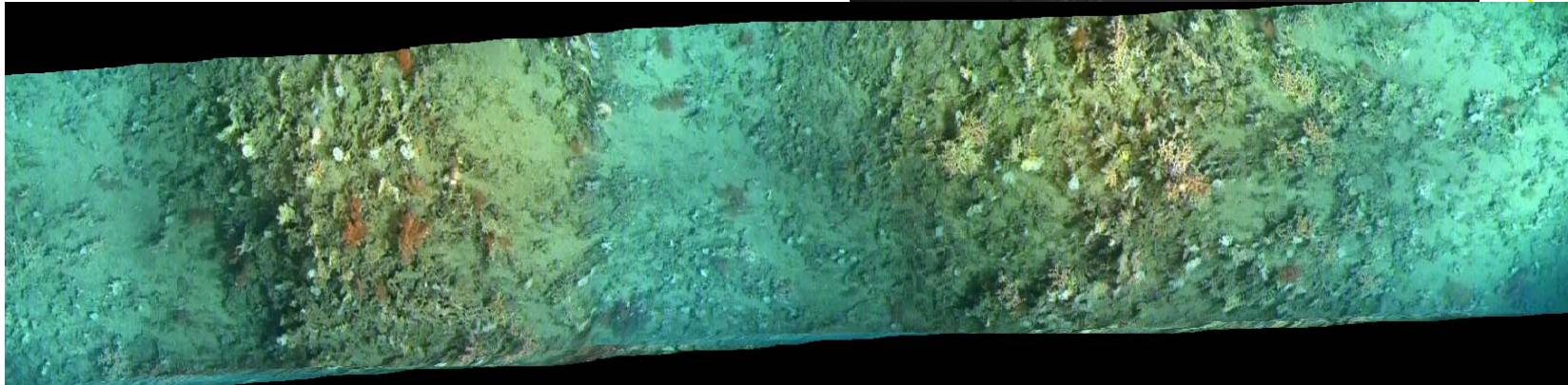

real time video mosaic, site Rockall

Cross Mob and teaming! Interoperability Training?

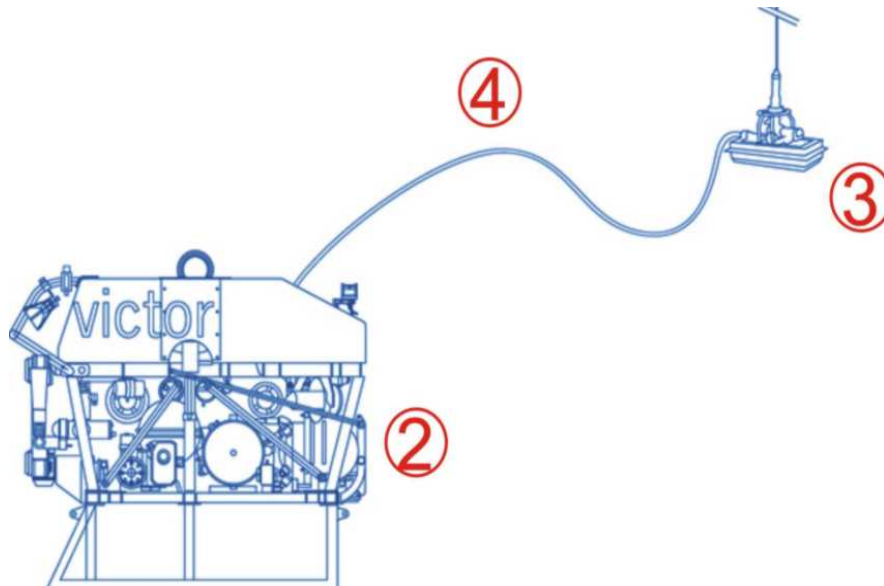

Survey AUVs for Sciences

3000m depth, 100km max range

modular “shared and interoperable” payloads

ASTERx, IDEFx 2000h, 3500km in 30 months

Patents/licences on AUV, Softs, LARS, payloads

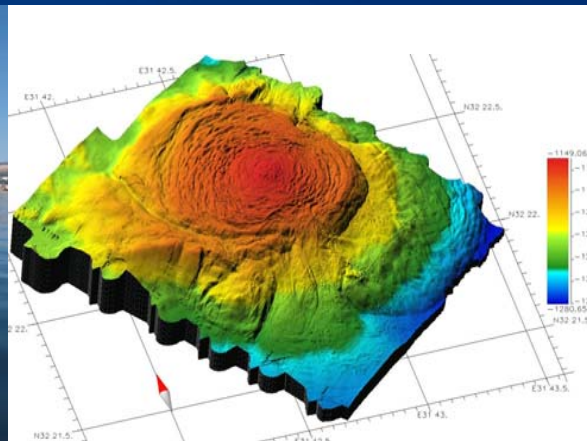
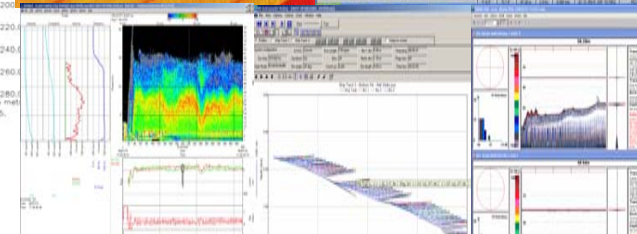
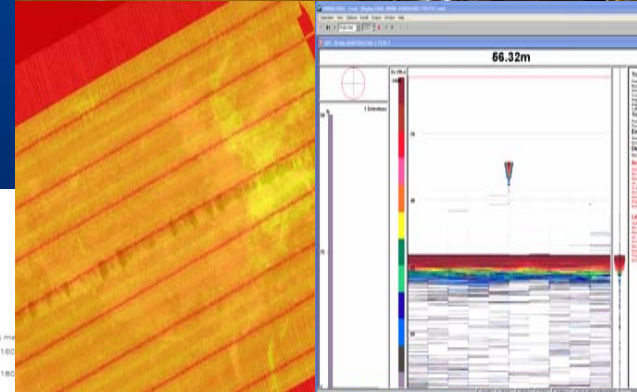

“Inside reality”

On the way to a realistic operational use

Again teaming and training is a key issue

Ifremer

II



SAR

Sismique & Acoustique & magnétométrie
à haute Resolution
Un des meilleurs sonar HR

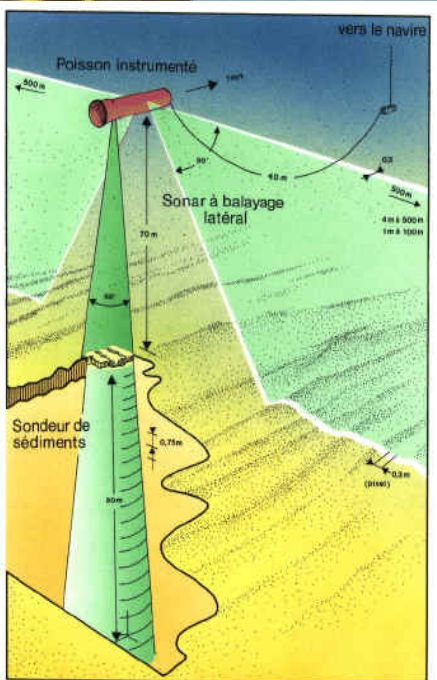

EXOCET: Deep Tow evolution

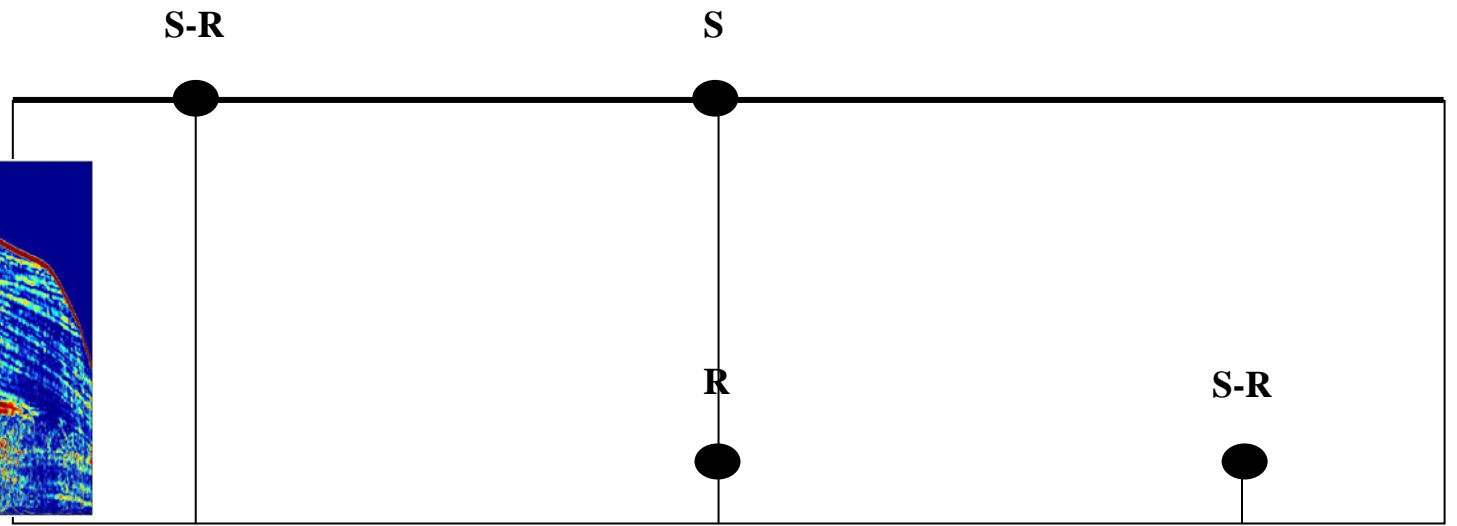
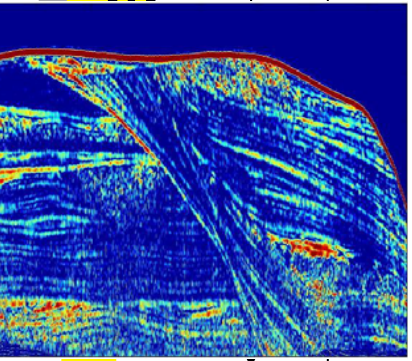
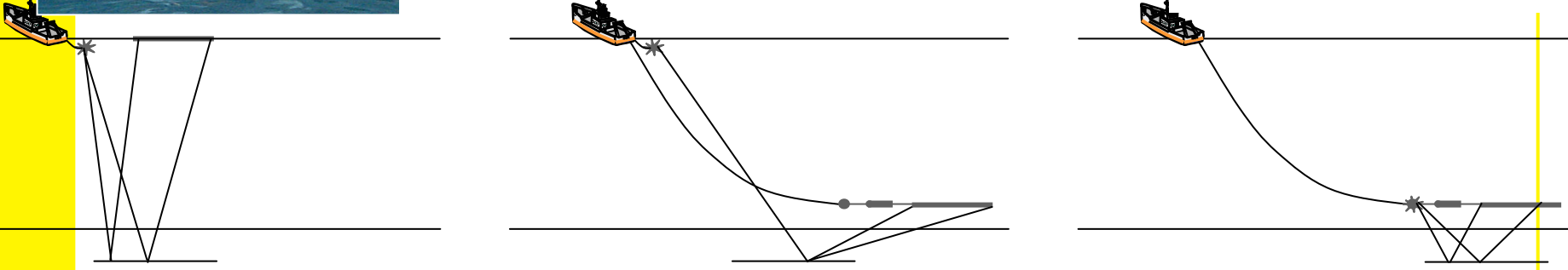
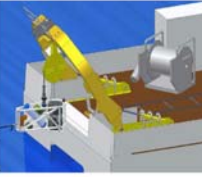
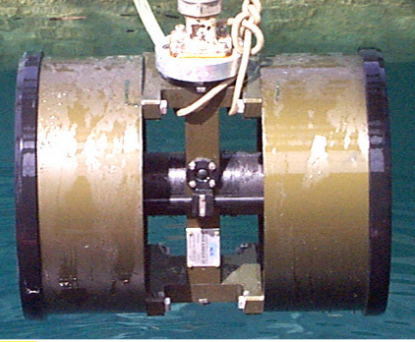

100 m

Technology : Janus-Helmholtz

Signal : FM [650, 2000 Hz]

Vertical resolution 0,6-1m

EXOCET Configurations

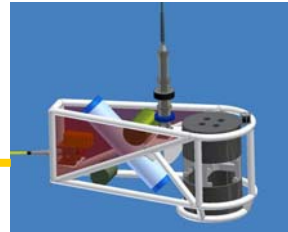

Winch 3000m
Small operational Team (2)
Size N/O Europe and +

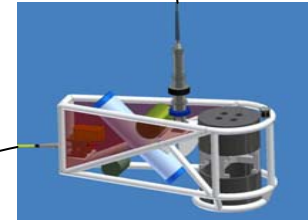
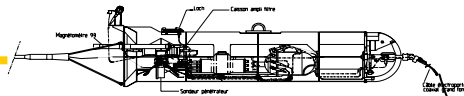

Winch 3000 ou 6000
Medium operational Team
(4/5)
1 Maintenance Shelter
(1) PC shelter
Size N/O Suroit +

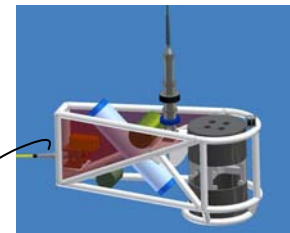

ANTARES; an existing large observatory (Neutrino telescope)

“Open” Test Bed site for Technology, design and installation

- 900 PMTs
- 12 lines
- 25 stairs / line
- 3 PMTs / stair

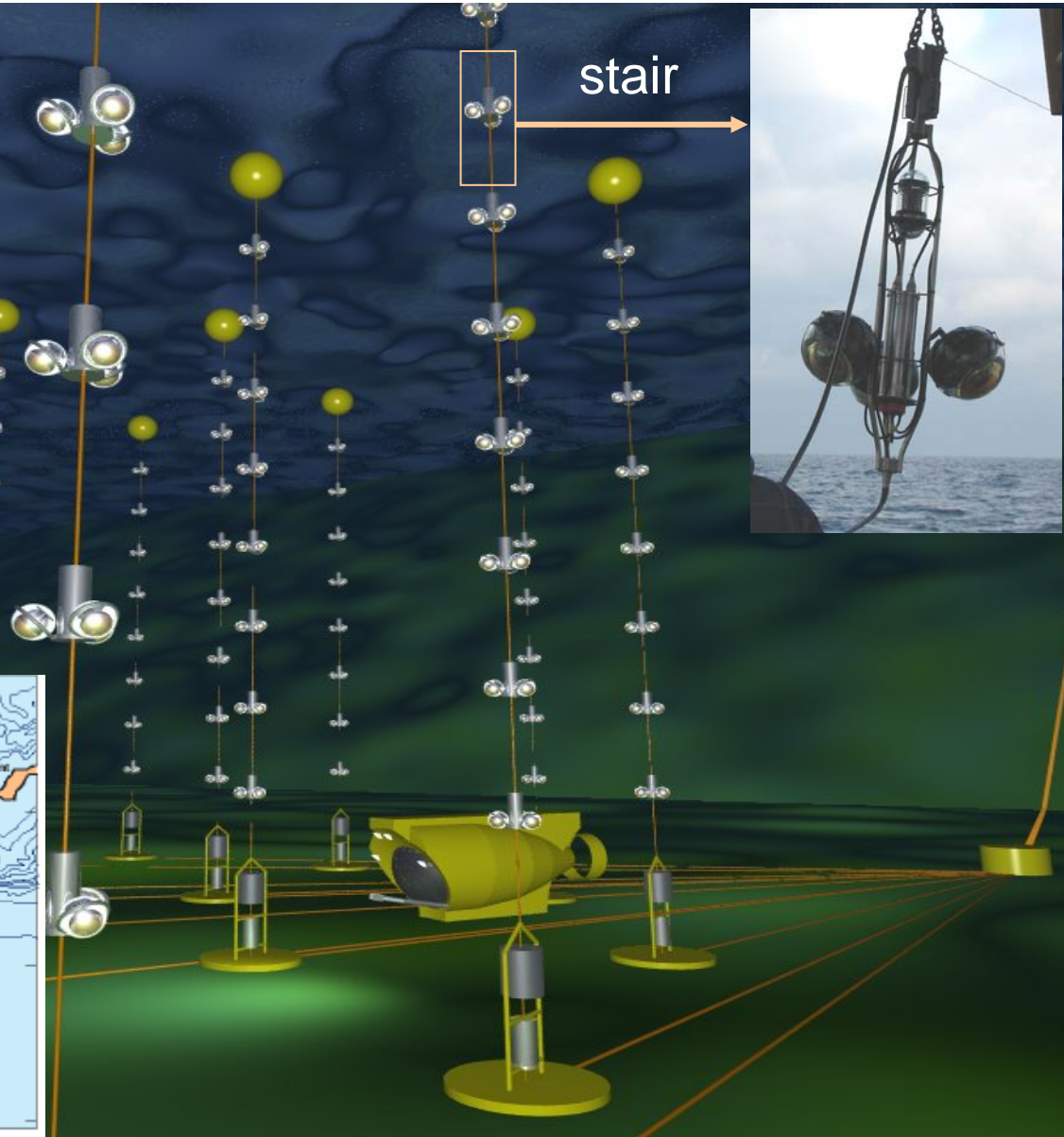

Operational engineering

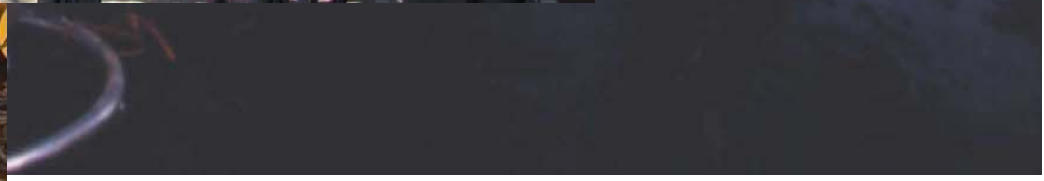
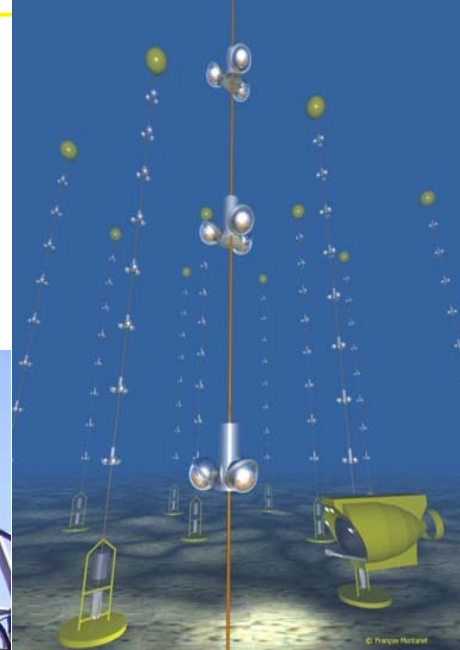

Ifremer (and partners) AUVs experiences

From RandD to operations: an example

- EPAULARD SBL system 1980- 300 dives up to 6000m, a supervised automaton (guide rope servoing)
- **Hybrid AUV**: Sirene->SWIMMER 2001, 30 dives 300m: Prototype, DR and New Precise Rangemeter with automatic Range selector also use for Docking + Sonar Based Docking
- **Intervention and inspection AUV**: ALIVE 2003 15 dives 70m, Inertial Nav + USBL + sonar - Optical DP
- 1995-2005 **Survey AUVs**

Ifremer

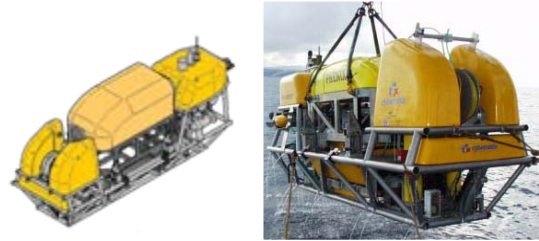

Ifremer-Cyx-Eu
Swimmer
2001

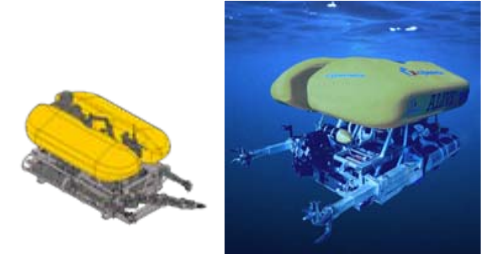

ALIVE
CX-Ifr-UE
2003



Epaulard
Ifremer
1980



Sirene
Ifremer-UE
1999

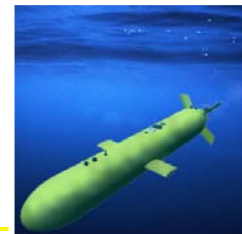

ASTERx
Ifremer
2005

Intervention AUV

a multi-purpose AUV

- fitted with manipulators
- operated in acoustically-supervised mode
- able to dock to the infrastructure and interact with it

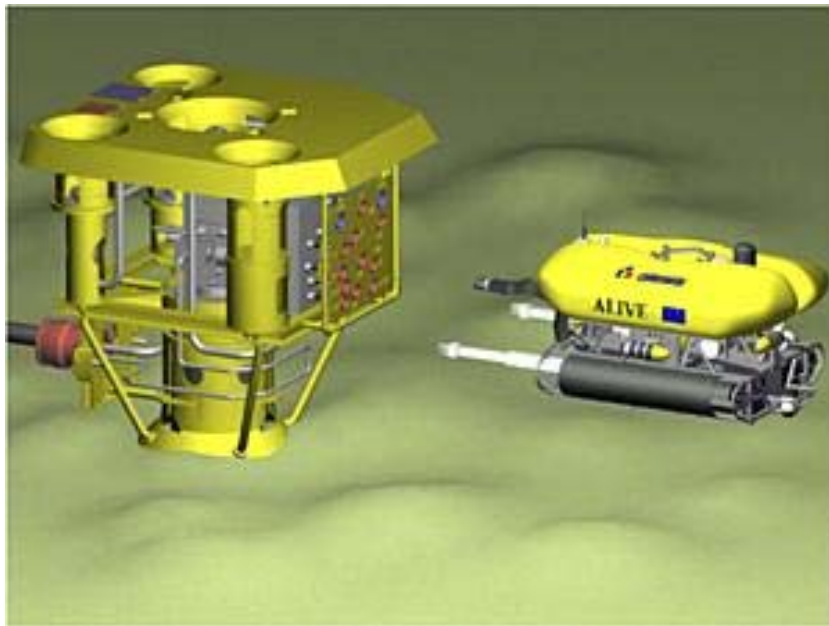

ALIVE (Ifremer/Cybernetix)

SWIMMER

- *Subsea Works Inspection and Maintenance with Minimum Environment ROV*
The first demonstration with Hybrid AUV



How a hybrid AUV operates

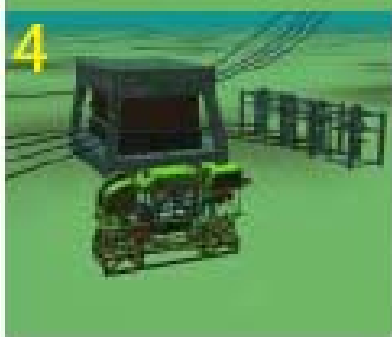
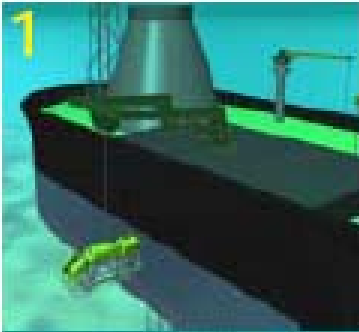

- 1 Launch
- 2 Transit
- 3 Approach
- 4 Docking
- 5 ROV operations



Ifre

(Cybernetrix-Ifremer Swimmer)

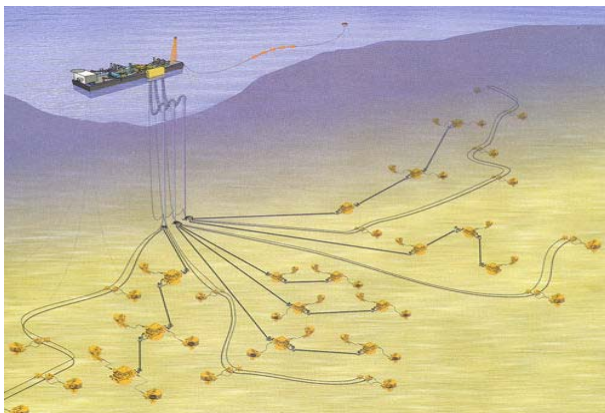



RandD ALIVE : Sea trials campaign October 2003

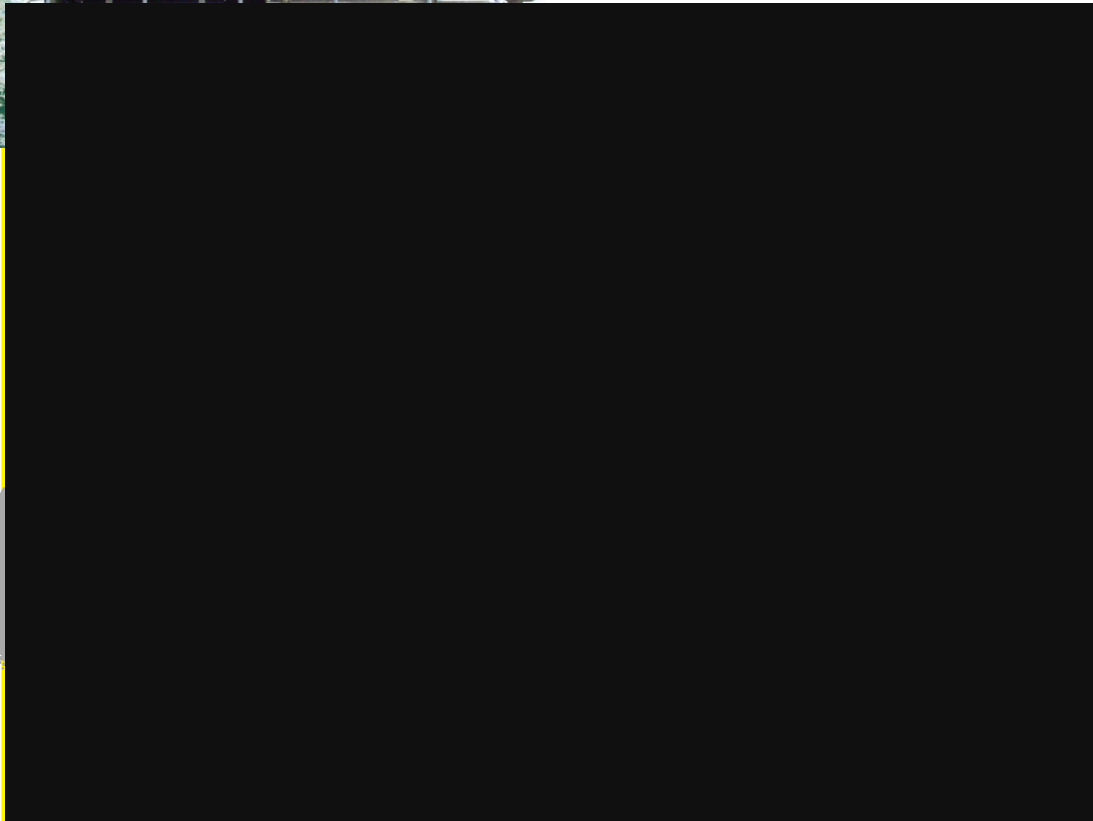

1

Docking panel before
intervention:
valve in horizontal position

2

Docking panel after
intervention:
valve in vertical position



- docking structure installed at 70 m depth
- docking and telemanipulation tasks achieved successfully

Generic Docking process with sonar and video (with CGG)

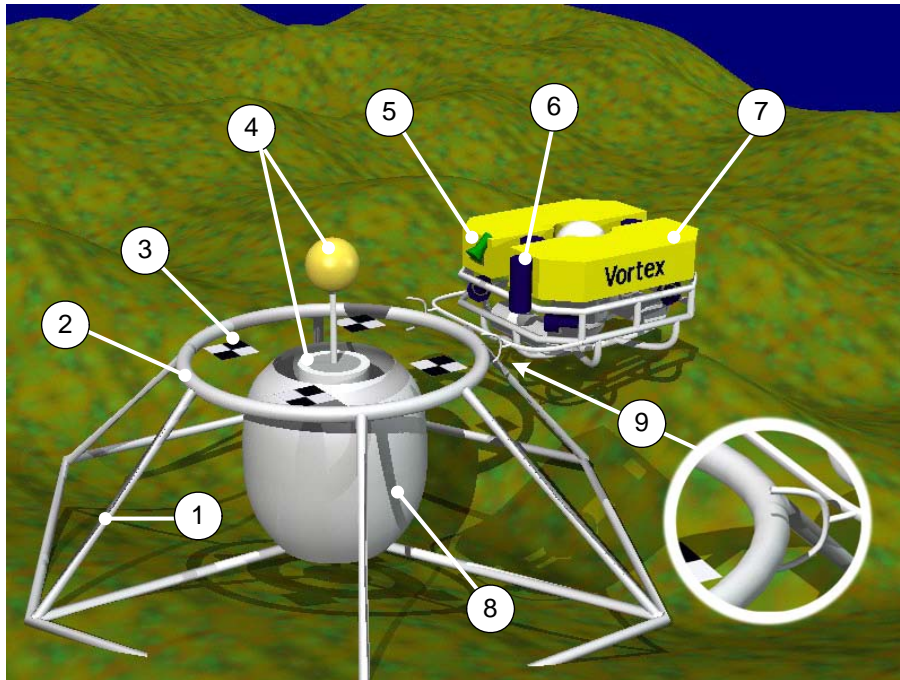

1. Seabed structure
2. Docking ring
3. Optic markers
4. OBS and receptacle

5. Vehicle camera
6. Scanning sonar
7. AUV
8. Sonar reflector
9. Grabbers

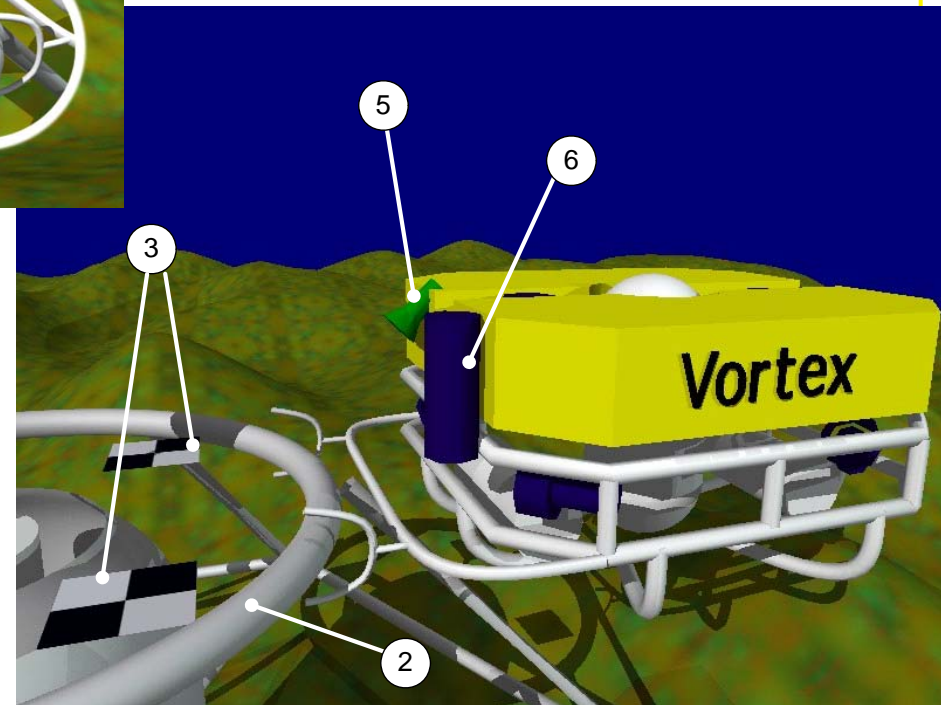

Heterogeneous autonomous marine vehicles

...what are they?



ASV
*Autonomous
Surface
Vehicles*



Underwater
Gliders

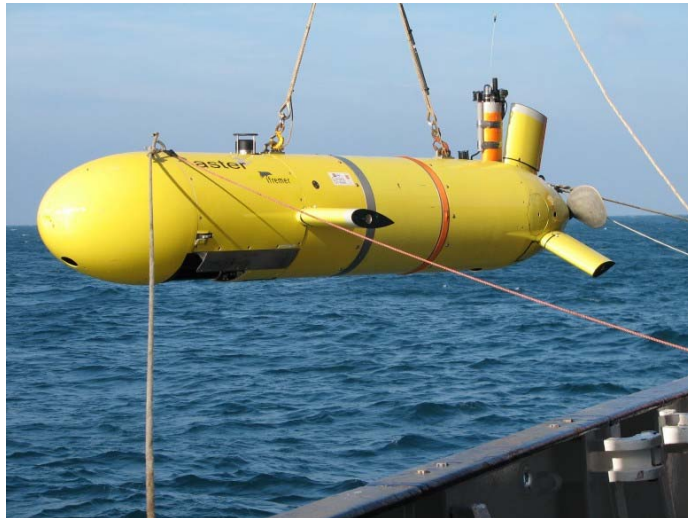

AUV
*Autonomous
Underwater
Vehicles*

... and:

*Autonomous
aerial drones,
ROVs,....*

Future ?: Integrated systems made of Heterogeneous Autonomous « fixed and mobile » systems, more services on observatories?



LEO Instrumentation Used for the 2000-2001 Experiment

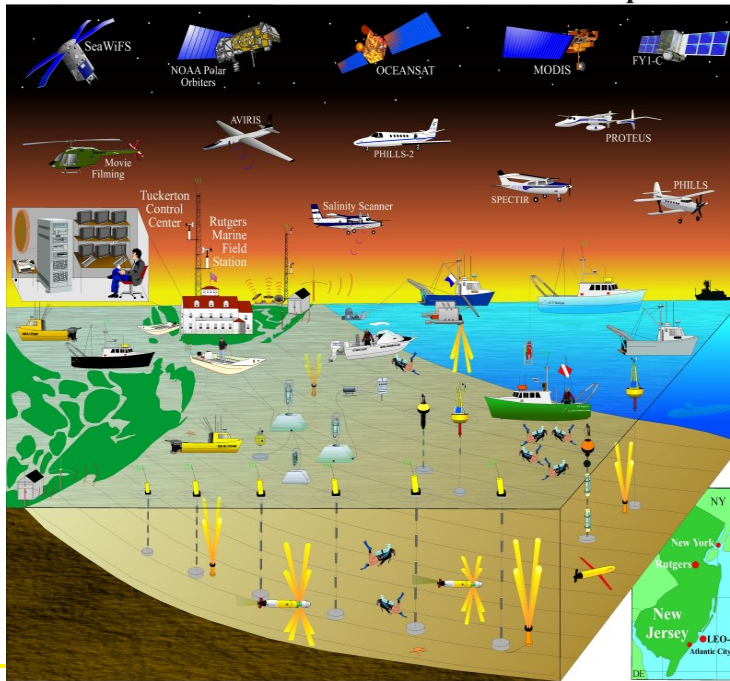

NEPTUNE
Instrumentation d'une plaque

